

# PRINTED LIGHT

## PRODUCT CATALOG 2016



R.W. "Dick" Hill, Jr. [[j.w.hill-led@hotmail.com](mailto:j.w.hill-led@hotmail.com)]

P. O. BOX 41841, HOUSTON, TEXAS 77241

713-867-8900 (24 HRS)

# PRINTED LIGHT

Providing light  
where it has never  
been before!



Healthy  
Green  
Seal

**1<sup>ST</sup> CHOICE**  
Innovative Lighting solution advancements™

R.W. "Dick" Hill, Jr. [[we-r-led@hotmail.com](mailto:we-r-led@hotmail.com)]

P. O. BOX 41641, HOUSTON, TEXAS 77241

713-887-8909 (24 HRS)

# TABLE OF CONTENTS

|                      |       |    |
|----------------------|-------|----|
| <b>CORE PRODUCTS</b> | ..... | 4  |
| <b>RETAIL</b>        | ..... | 17 |
| <b>DECOR</b>         | ..... | 28 |
| <b>EVENTS</b>        | ..... | 31 |
| <b>AUTO</b>          | ..... | 35 |
| <b>SAFETY</b>        | ..... | 37 |

# PRINTED LIGHT PANELS

Printed Light™ uses nano-molecular technology to create light panels as thin as laminated paper.

It's water-resistant, lightweight, and 100% environmentally - friendly (no VOC's). The heat tolerance ranges from -20° to 200° Fahrenheit. Printed Light consumes only 0.0625 Watts/sq. ft. and has a low heat output.

Our panels are printed on a single substrate, which allows for flexible applications as well as customization for all of your product needs. Printed Light™ is the first of its kind to be able to use ink with illuminating properties through nanotechnology and is available to our customers at a very low cost with a 1 year limited manufacturer's warranty.

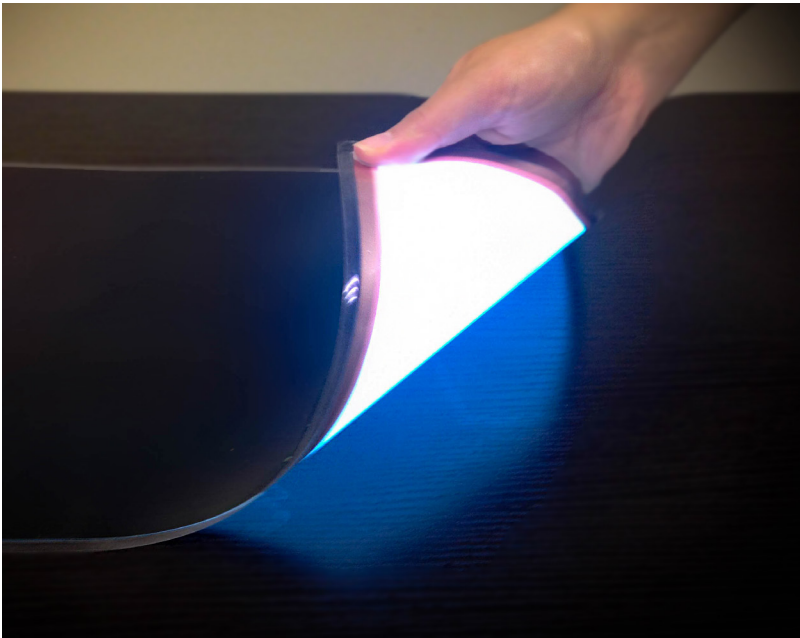

**Paper-thin** - Just as it proclaims, Printed Light™ panels are as thin as paper making it easier to implement into various applications and lowering shipping costs as well.

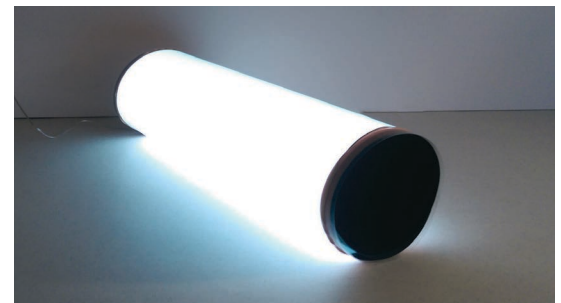

**Flexible** - These panels can be manipulated/maneuvered almost any which way with its incredible flexibility.

**Bright** - Printed Light™ panels get up to 800 lumens, the equivalent of LED or EL brightness but using a fraction of the power consumption, no heat build up, and a significantly longer life span.



# 4 x 10 PANEL & DRIVER

This product is DC driven & easily powered with one 9V battery.

Most commonly used for:

- Leave-Behinds
- Wearables

Features:

- Panel cord measures 36 in.
- Panel cord plugs directly into driver

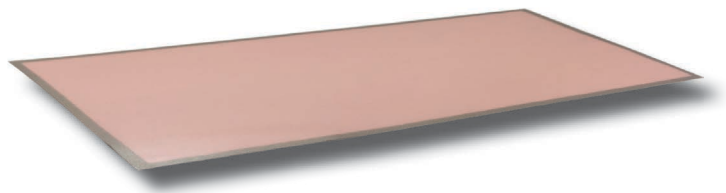

Panel

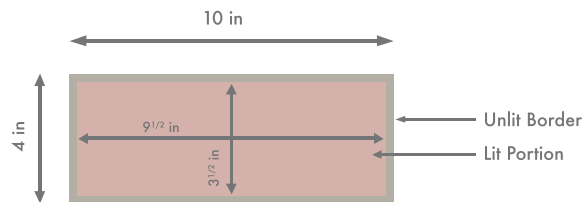

Driver

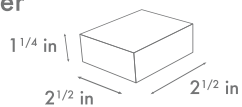

## SHIPPING INFORMATION

|                    |                     |
|--------------------|---------------------|
| ITEM: 4 x 10 PANEL | ITEM: 4 x 10 DRIVER |
| WEIGHT W/O PACKING | WEIGHT W/O PACKING  |
| 0.8 OZ.            | 1.9 OZ.             |



R.W. "Dick" Hill, Jr. [[we-r-led@hotmail.com](mailto:we-r-led@hotmail.com)]

P. O. BOX 41641, HOUSTON, TEXAS 77241

713-867-8909 (24 HRS)

# 8 x 10 PANEL & DRIVER

Most commonly used for:

- Photo Frames
- Retail Acrylics

Features:

- Panel cord measures 36 in.
- Driver cord measures 55 in.

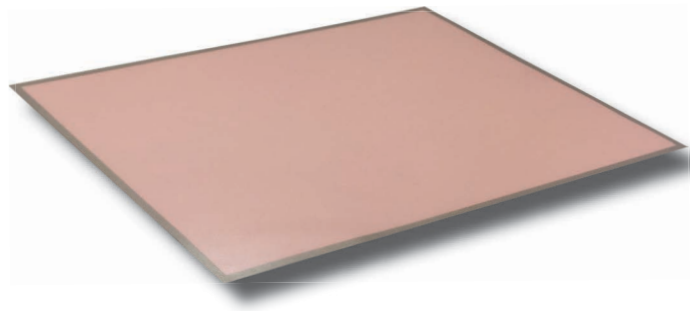

Panel

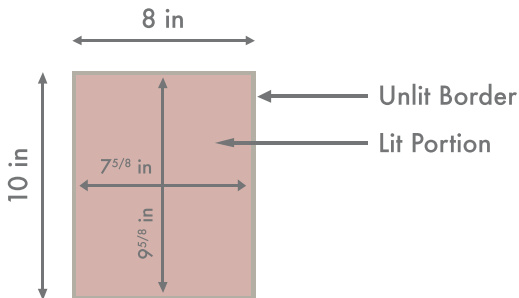

Driver

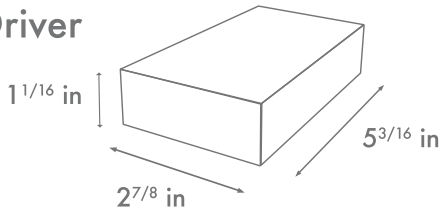

## SHIPPING INFORMATION

|                    |                     |
|--------------------|---------------------|
| ITEM: 8 x 10 PANEL | ITEM: 8 x 10 DRIVER |
| WEIGHT W/O PACKING | WEIGHT W/O PACKING  |
| 1.8 OZ.            | 11.9 OZ.            |



# 11 X 17 PANEL & DRIVER

Most commonly used for:

- Posters

Features:

- Panel cord measures 36 in.
- Driver cord measures 55 in.

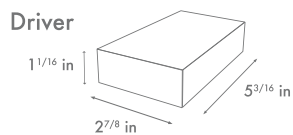
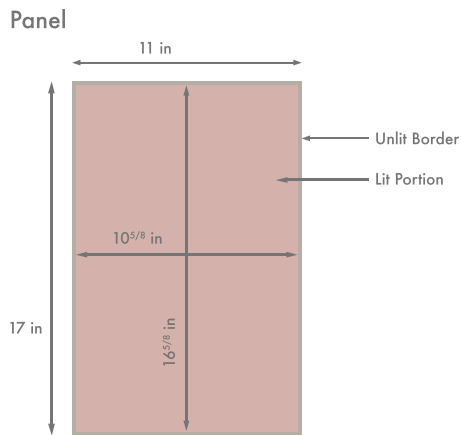
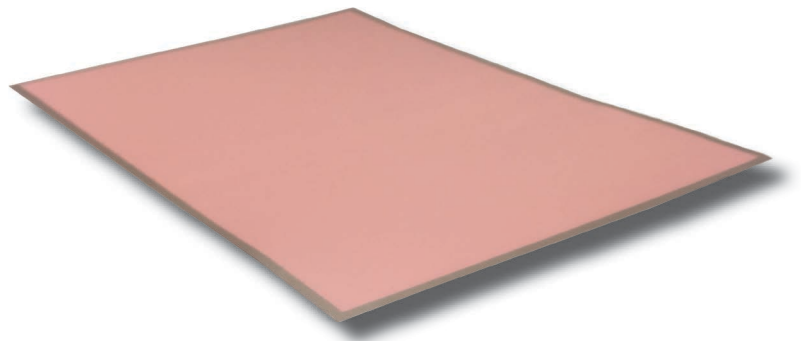

## SHIPPING INFORMATION

|                     |                      |
|---------------------|----------------------|
| ITEM: 11 x 17 PANEL | ITEM: 11 x 17 DRIVER |
| WEIGHT W/O PACKING  | WEIGHT W/O PACKING   |
| 3.6 OZ.             | 11.9 OZ.             |



# 18 x 24 PANEL & DRIVER

Most commonly used for:

- Posters

Features:

- Panel cord measures 36 in.
- Driver cord measures 55 in.
- Driver includes flash button and dimmer dial

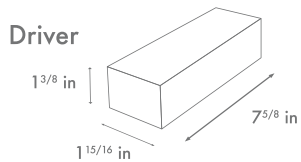
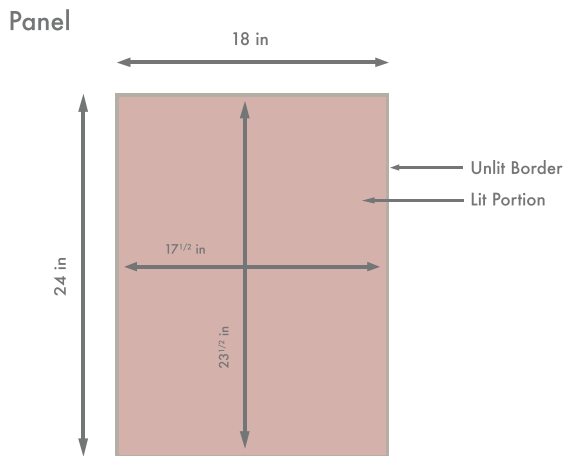
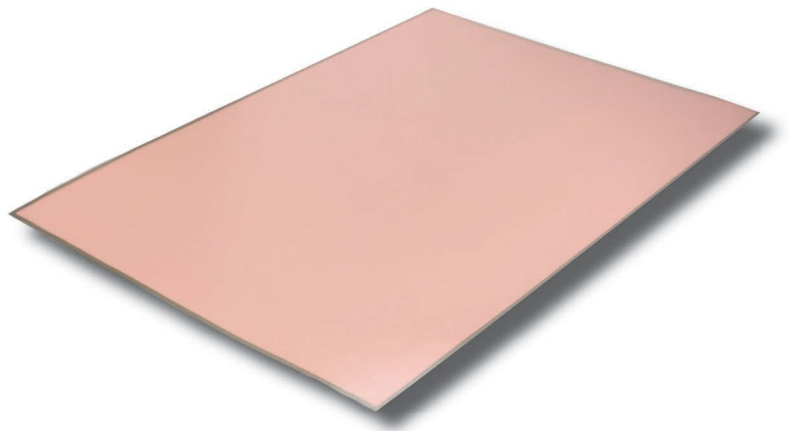

## SHIPPING INFORMATION

|                     |                      |
|---------------------|----------------------|
| ITEM: 18 x 24 PANEL | ITEM: 18 x 24 DRIVER |
| WEIGHT W/O PACKING  | WEIGHT W/O PACKING   |
| 7.8 OZ.             | 12.1 OZ.             |





# 22 x 28 PANEL & DRIVER

Most commonly used for:

- Posters

Features:

- Panel cord measures 36 in.
- Driver cord measures 60 in.
- Driver includes flash switch

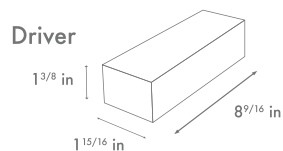
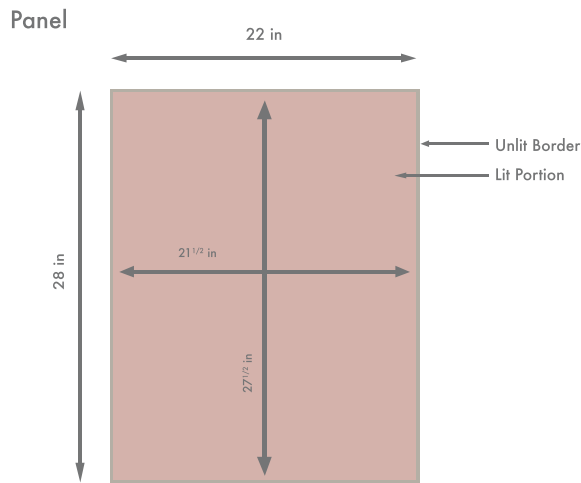
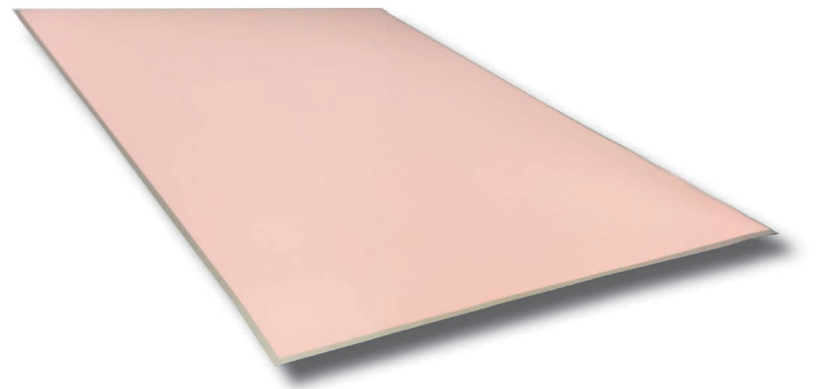

## SHIPPING INFORMATION

|                     |                      |
|---------------------|----------------------|
| ITEM: 22 x 28 PANEL | ITEM: 22 x 28 DRIVER |
| WEIGHT W/O PACKING  | WEIGHT W/O PACKING   |
| 11.1 OZ.            | 1 LB., 0.3 OZ.       |



# 24 x 36 PANEL & DRIVER

Most commonly used for:

- Posters

Features:

- Panel cord measures 36 in.
- Driver cord measures 60 in.
- Driver includes flash button

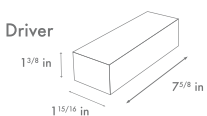
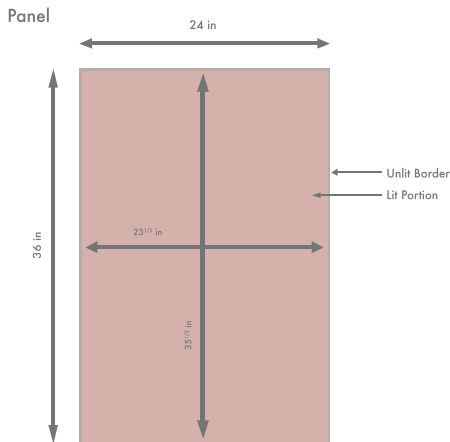
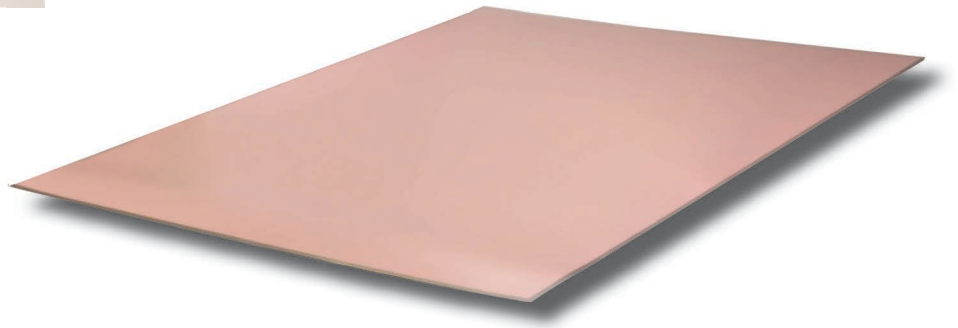

## SHIPPING INFORMATION

|                     |                      |
|---------------------|----------------------|
| ITEM: 24 x 36 PANEL | ITEM: 24 x 36 DRIVER |
| WEIGHT W/O PACKING  | WEIGHT W/O PACKING   |
| 1 LB, 4 OZ.         | 1 LB, 0.1 OZ.        |



# 24 x 48 PANEL & DRIVER

Most commonly used for:

- Floor Mats

Features:

- Panel cord measures 36 in.
- Driver cord measures 60 in.
- Driver includes flash button, flash speed dial and dimmer dial

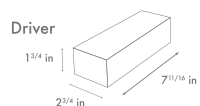
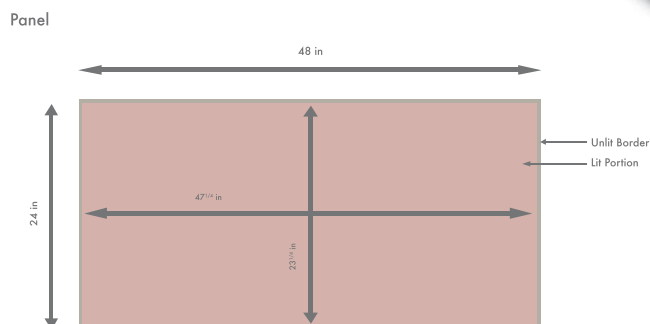
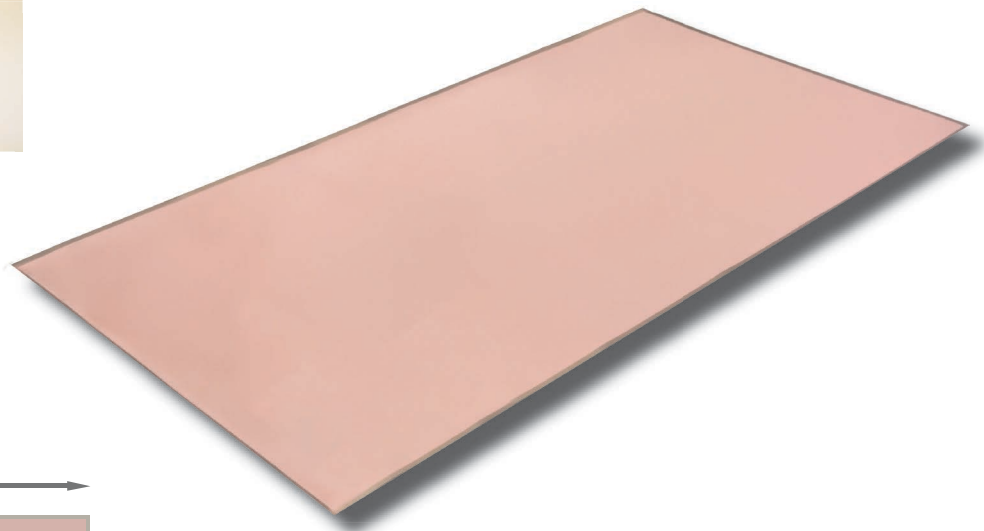

## SHIPPING INFORMATION

ITEM: 24 x 48 PANEL

ITEM: 24 x 48 DRIVER

WEIGHT W/O PACKING

WEIGHT W/O PACKING

1 LB, 2.8 OZ.

1 LB, 4.6 OZ.



R.W. "Dick" Hill, Jr. [[we-r-led@hotmail.com](mailto:we-r-led@hotmail.com)]

P. O. BOX 41641, HOUSTON, TEXAS 77241

713-867-8909 (24 HRS)

# 27 x 40 PANEL & DRIVER

Most commonly used for:

- Movie Posters

Features:

- Panel cord measures 36 in.
- Driver cord measures 60 in.
- Driver includes flash button, flash speed dial and dimmer dial

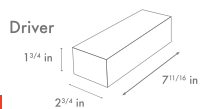
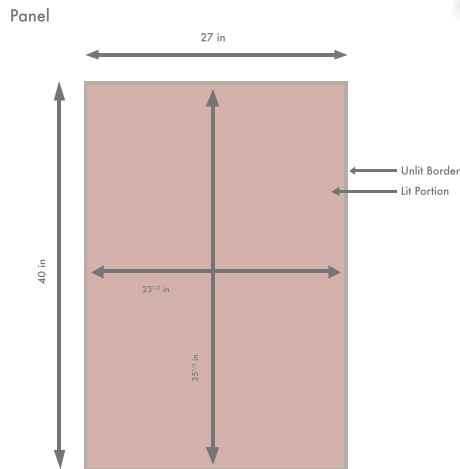
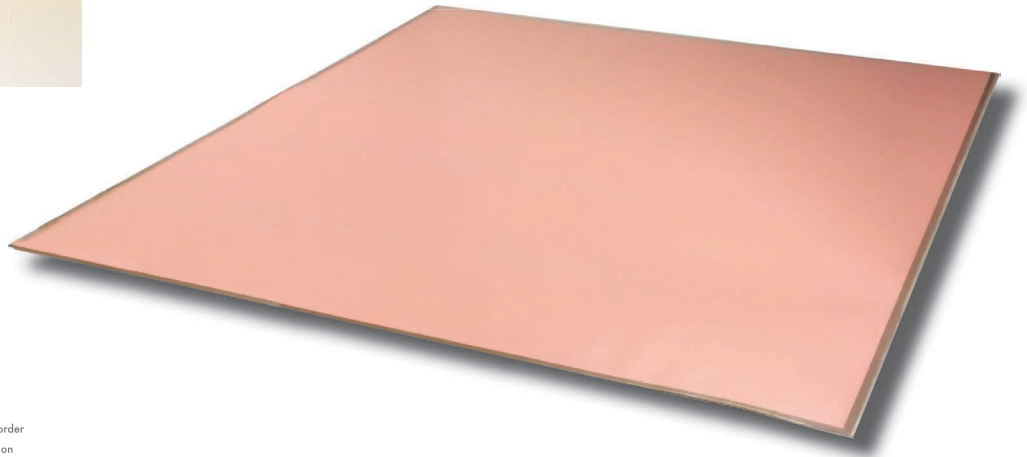

## SHIPPING INFORMATION

|                     |                      |
|---------------------|----------------------|
| ITEM: 27 x 40 PANEL | ITEM: 27 x 40 DRIVER |
| WEIGHT W/O PACKING  | WEIGHT W/O PACKING   |
| 1 LB, 3 OZ.         | 1 LB, 4.4 OZ.        |



# PRINTED LIGHT MAGNETS

Printed Light™ Magnets have the same basic technology as Printed Light™ panels simply printed directly on to magnets. With this product, displaying options are largely increased.

This particular product can be programmed to light up sequentially, flash, etc. These magnets are DC powered and come with a car adapter that plugs into any standard car

cigarette lighter.

Features:

- Arrows programmed to light up in sequence
- Arrow colors are yellow off, green on
- Includes driver with car adapter
- Driver cord measures 9 ft. & magnet cord 9.5 ft.
- Lasts 60 hours on a 12 V, 20 Ah battery

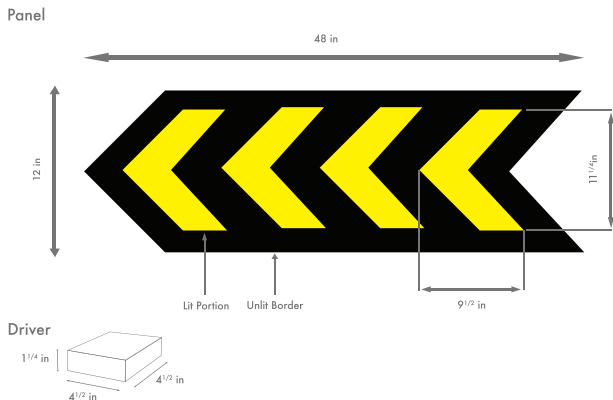

## SHIPPING INFORMATION

|                    |                        |
|--------------------|------------------------|
| ITEM: PL MAGNET    | ITEM: PL MAGNET DRIVER |
| WEIGHT W/O PACKING | WEIGHT W/O PACKING     |
| 3.086 LBS.         | 0.8819 LBS.            |



# PRINTED LIGHT LETTERING

Printed Light™ Lettering can be used in a variety of ways, but currently it is most popularly used in wearable technology.

This product is easily powered with 2AA batteries. Standard size Printed Light™ lettering is 4"x10" and can fit a maximum of 7 letters comfortably. This wearable tech also has multiple power modes such as: on, flash, and rapid flash. With safety in mind, these lit

vests are visible from hundreds of feet away.

Features:

- Powered by two AA batteries (3V)
- Three modes: solid on, flash, rapid flash
- Clip-on driver
- Panel cord measures 3 ft.

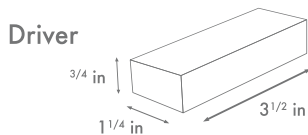

## SHIPPING INFORMATION

|                     |                      |
|---------------------|----------------------|
| ITEM: PL LETR PANEL | ITEM: PL LETR DRIVER |
| WEIGHT W/O PACKING  | WEIGHT W/O PACKING   |
| 0.8 OZ.             | 1.1 OZ.              |



# PRINTED LIGHT STARTER KIT

Printed Light™ Starter Kit comes with an 8x10, 11x17, and an 18x24 in. panel. These are our most popular sizes and the perfect package to get you started on your illuminated marketing. By bundling, this kit offers a much lower price to ship and who doesn't love to save?

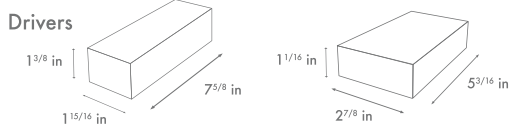
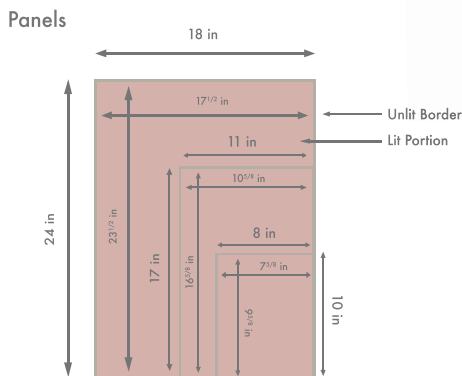
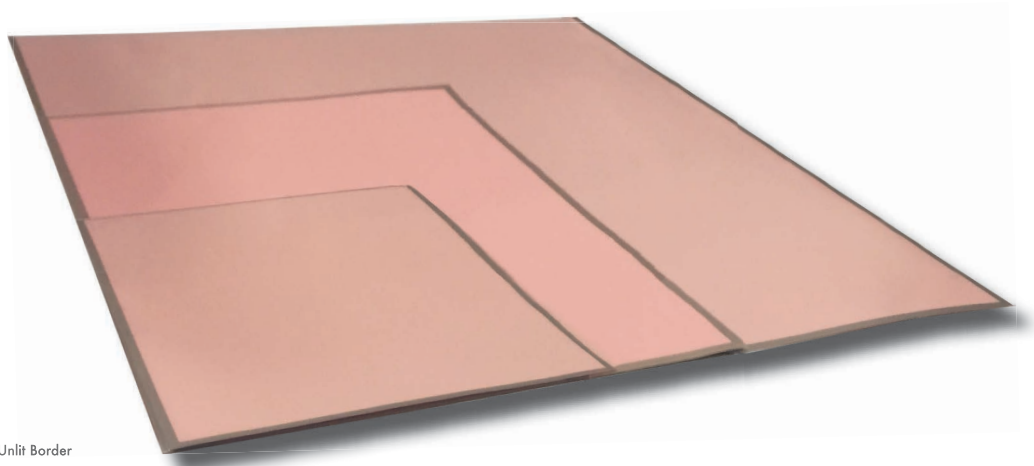

## SHIPPING INFORMATION

|                    |                     |
|--------------------|---------------------|
| ITEM: STARTER KIT  | ITEM: S KIT DRIVERS |
| WEIGHT W/O PACKING | WEIGHT W/O PACKING  |
| 13.2 OZ.           | 35.9 OZ.            |



## PRINTED CUSTOM DESIGNS

Printed Light™ Custom Designs are unique in that the logo or design is printed directly onto the panel using the same Printed Light™ Panel technology. Custom designs allow you to illuminate your logo or message without the complicated installation of a light box.

This product is AC powered and comes with a standard 110v AC adapter. Die-cutting is also available, allowing your logo to pop!

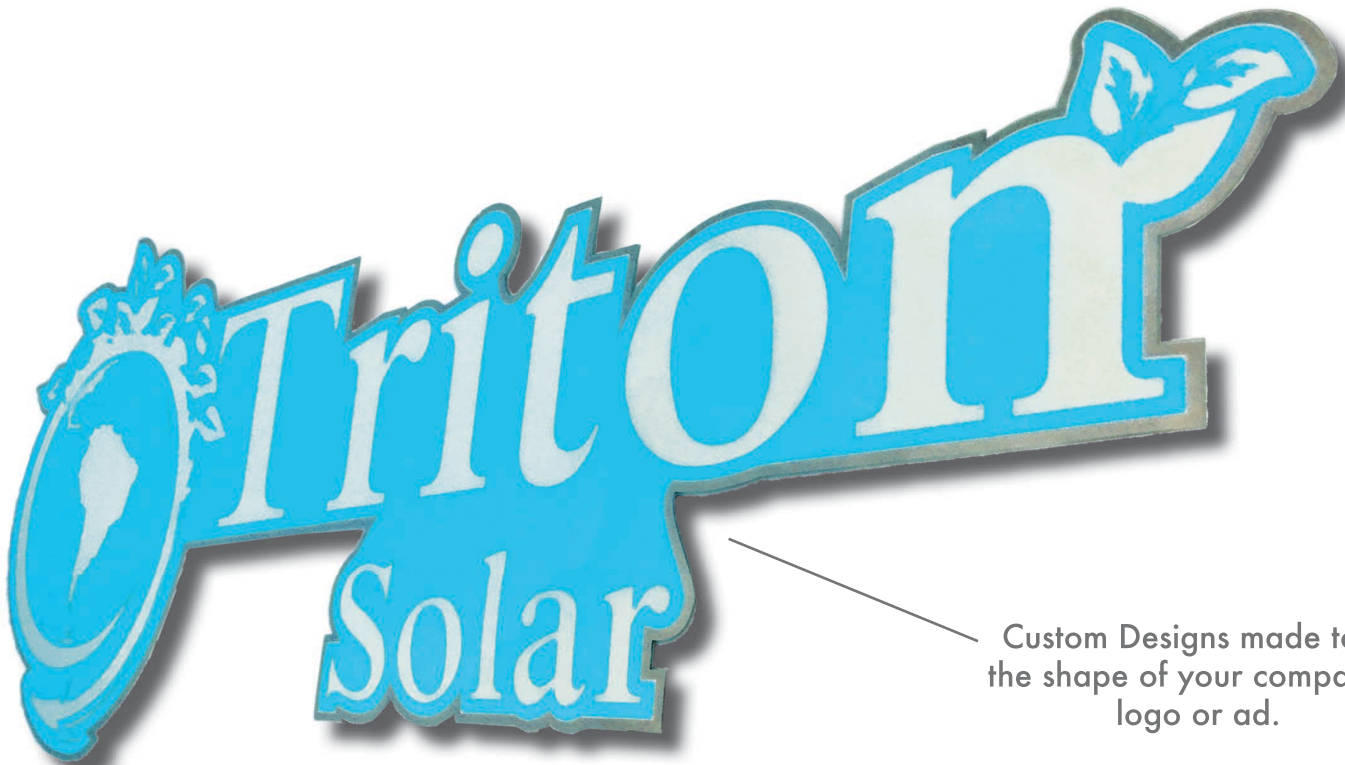

Custom Designs made to fit the shape of your company's logo or ad.

SHIPPING & DRIVER INFORMATION VARY DEPENDING ON DESIGN



R.W. "Dick" Hill, Jr. [[we-r-led@hotmail.com](mailto:we-r-led@hotmail.com)]

P. O. BOX 41641, HOUSTON, TEXAS 77241

713-967-8909 (24 HRS)



# BACKLIT SNAP FRAMES

Advertise your business in snap frames.  
Backlight your promotional ads with Printed Light™.

Pair it with; 8x10, 11x17, 18x24, 22x28, 24x36, or 27x40 panels.



Our preferred vendors for these frames are:



R.W. "Dick" Hill, Jr. [[we-r-led@hotmail.com](mailto:we-r-led@hotmail.com)]

P. O. BOX 41641, HOUSTON, TEXAS 77241

713-867-8909 (24 HRS)

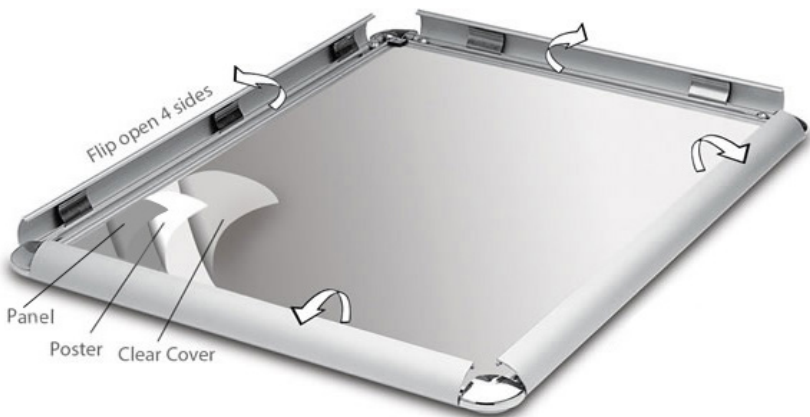

# RETAIL COUNTER ACRYLIC

Do your countertops need a little pizzazz? Light it up with an 8x10 retail counter acrylic and showcase your newest product.

## Features:

- Panel cord measures 36 in.
- Driver cord measures 55 in.

## Dimensions(in):

- Panel: 8 x 10
- Driver: 5 3/16 x 2 7/8 x 1 1/16



Our preferred vendors for these  
Acrylic Displays are:



R.W. "Dick" Hill, Jr. [[we-r-led@hotmail.com](mailto:we-r-led@hotmail.com)]

P. O. BOX 41641, HOUSTON, TEXAS 77241

713-867-8909 (24 HRS)

# RETAIL FIXTURE & ENDCAPS

Marketers will swear up & down when it comes to the importance of product placement & displays. Increase your ROI by strategically placing & highlighting your ads.

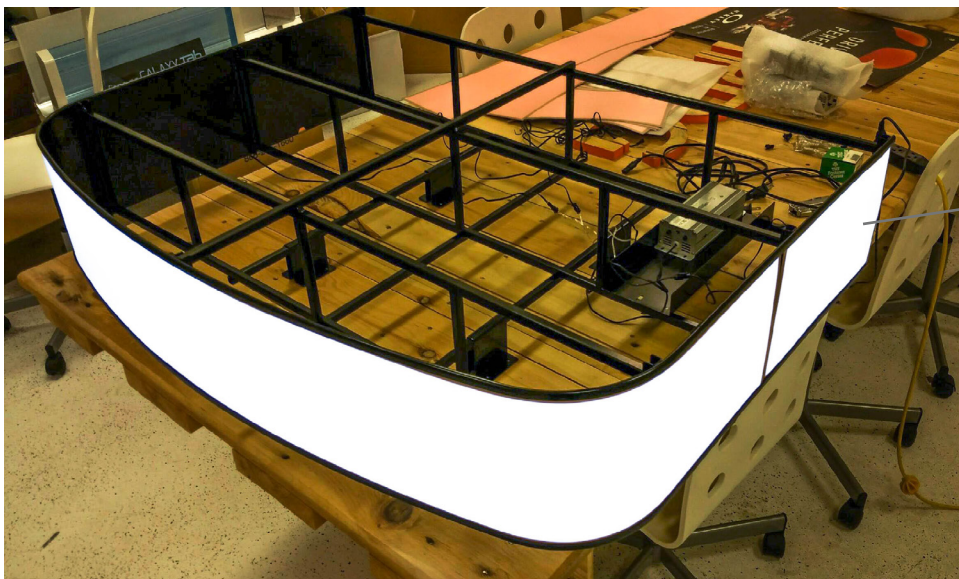

Printed Light™ Panels retrofitted



Our preferred vendor for these fixtures is:



R.W. "Dick" Hill, Jr. [[we-r-led@hotmail.com](mailto:we-r-led@hotmail.com)]

P. O. BOX 41641, HOUSTON, TEXAS 77241

713-867-8909 (24 HRS)

# GONDOLAS

Lighting up the tops of gondolas is an effective way to capture your audience. Also, it looks really, really cool.

Printed Light™ Panels retrofitted



Our preferred vendor for Gondolas is:



R.W. "Dick" Hill, Jr. [[we-r-led@hotmail.com](mailto:we-r-led@hotmail.com)]

P. O. BOX 41641, HOUSTON, TEXAS 77241

713-867-8909 (24 HRS)

# CANVERTISING

It may not be the first thing you think of when it comes to advertising, but it's something everyone is always in search of. Trash cans - yes we said it. Advertise on cans.

## Features:

- For indoor use or outdoor (with a cover)



Printed Light™ Panel  
inserted behind cut-out

Our preferred vendor for  
Canvertising is:



R.W. "Dick" Hill, Jr. [[we-r-led@hotmail.com](mailto:we-r-led@hotmail.com)]

P. O. BOX 41641, HOUSTON, TEXAS 77241

713-867-8909 (24 HRS)

Pictured with a 22 x 28 in. Printed Light™ panel

# FLOOR MATS

First impressions last a lifetime so why not light up the first thing people see when approaching your storefront?



Flexible Plastic Enclosure to prevent slips or falls

Interchangeable overlays for infinite design possibilities

Our preferred vendors for these floor mats are:



R.W. "Dick" Hill, Jr. [[we-r-led@hotmail.com](mailto:we-r-led@hotmail.com)]

P. O. BOX 41641, HOUSTON, TEXAS 77241

713-867-8909 (24 HRS)

# PURSE LINER

Anyone who has ever carried a purse knows how difficult it can be to find their things in it. We solve this problem by presenting the purse liner - DC powered with options of 9v or 3v battery operation.

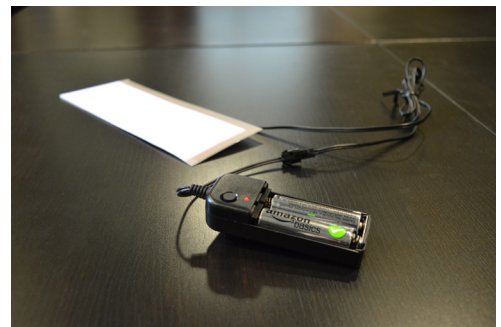

3v driver —



9v driver —

Our preferred vendor for these purse liners is:



R.W. "Dick" Hill, Jr. [[we-r-led@hotmail.com](mailto:we-r-led@hotmail.com)]

P. O. BOX 41641, HOUSTON, TEXAS 77241

713-867-8909 (24 HRS)

# TABLETOP MENU

Every restaurant wants to upsell desserts, but by the time the waiter or waitress comes back out with the menu, most of us are full and desserts are an afterthought. Why not have it lit up front and center on the table so that while you are eating dinner, the thought of sweets dancing in your tummy becomes too irresistible to turn away. Below is a 2 x 4 panel sitting

on top of a table with a dessert menu overlay.

This menu can made in any standard or custom size as well.



Frosted Glass Cover protects panel & overlay

Our preferred vendor for these tabletop menus is:



R.W. "Dick" Hill, Jr. [[we-r-led@hotmail.com](mailto:we-r-led@hotmail.com)]

P. O. BOX 41641, HOUSTON, TEXAS 77241

713-867-8909 (24 HRS)



# PAVEMENT SIGN

This dual-sided pavement sign is optimal for store-front advertising. Not only will it be eye-catching during the day, but even more so during the evening.



———— double-sided for dual display

———— durable, weather-resistant, and portable

Our preferred vendors for pavement signs are:



Healthy  
Green  
Seal

**1<sup>ST</sup> CHOICE**  
Innovative Lighting solution advancements™

R.W. "Dick" Hill, Jr. [[we-r-led@hotmail.com](mailto:we-r-led@hotmail.com)]

P. O. BOX 41641, HOUSTON, TEXAS 77241

713-867-8909 (24 HRS)

# RETRACTABLE BANNER

Retractable banners are an easy quick way to display custom color graphics at seminars, presentations, sales promotions, events, corporate parties, retail stores, table tops, counter tops and more. These freestanding displays feature a winding system that protects and unfolds its inside banner in a matter of seconds. They are incredibly lightweight and easily transportable.



Our preferred vendor for these retractable banners is:



R.W. "Dick" Hill, Jr. [[we-r-led@hotmail.com](mailto:we-r-led@hotmail.com)]

P. O. BOX 41641, HOUSTON, TEXAS 77241

713-867-8909 (24 HRS)

Thin, lightweight design

# COOLER DOOR HANDLES

These cooler door handles are easy to install and advertising inserts can be changed at any time. Retailers benefit by creating new revenue streams, driving consumers to a specific brand or promotion, and marketers benefit as it's the last thing the consumer sees and touches before entering the cooler selection.

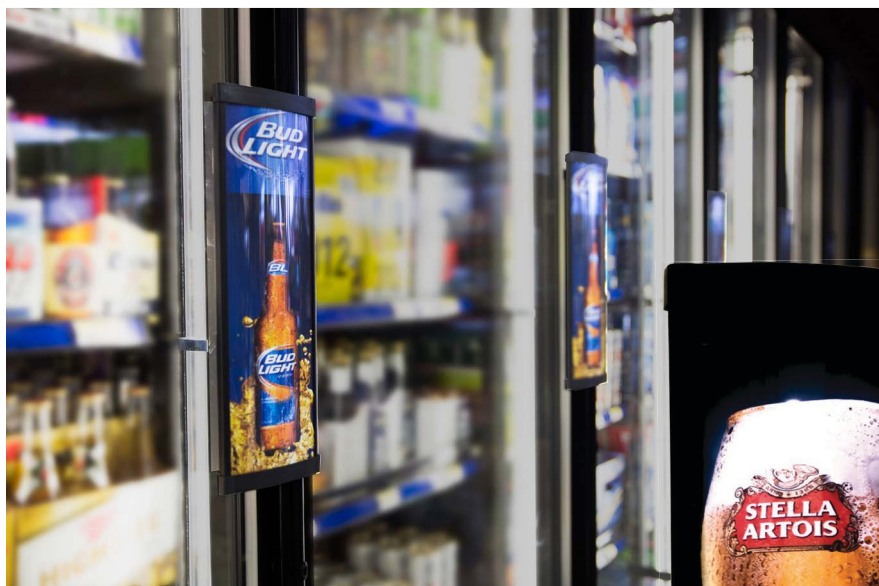

Our preferred vendor for these cooler door handles is:



R.W. "Dick" Hill, Jr. [[we-r-led@hotmail.com](mailto:we-r-led@hotmail.com)]

P. O. BOX 41641, HOUSTON, TEXAS 77241

713-867-8909 (24 HRS)



# BACKLIT STANDARD FRAMES

Because of Printed Light's customizable capability, it can be fitted to any standard size frame; allowing you to illuminate any memory or masterpiece.



Customized to fit multiple sizes



Our preferred vendor for these frames is:



R.W. "Dick" Hill, Jr. [[we-r-led@hotmail.com](mailto:we-r-led@hotmail.com)]

P. O. BOX 41641, HOUSTON, TEXAS 77241

713-867-8909 (24 HRS)

# AMBIENT LIGHT SHADES(BULBLESS)

Didn't think lamps could be made without bulbs? Think again! These ambient light shades emit a comforting glow without the use of those pesky lightbulbs.

- Featured:
- 11" x 17" panel
- Custom sizes are available.

Assembly Instructions:

- Adhere the panel and the overlay to the lamp with double-sided tape.



Printed Light™ Panel formed in a cylinder shape with edges connected.

Our preferred vendor for these bulbless lamp shades is:



R.W. "Dick" Hill, Jr. [we-r-led@hotmail.com]  
 P. O. BOX 41641, HOUSTON, TEXAS 77241 713-867-8909 (24 HRS)

# UNDER LIGHTING

Customize your interior space by simply adding Printed Light™ underneath countertops, shelves, or cabinetry.

Features:

- Suggested Panels: 8 x 48 in or 8 x 76 in
- Adhere with double-sided tape or velcro



— Versatile for different angles & curves



Printed Light™ Panel adhered from the back creates a slim design with minimal visibility.

Our preferred vendor for underlighting is:



R.W. "Dick" Hill, Jr. [[we-r-led@hotmail.com](mailto:we-r-led@hotmail.com)]

P. O. BOX 41641, HOUSTON, TEXAS 77241

713-867-8909 (24 HRS)

## A-FRAMES

Pick up your promotion & go with lit A-frames. These light, durable, and transportable signs are great for any event, especially evening occasions for increased visibility.



Capture passbyers attention with illuminated marketing.

Our preferred vendors for A-Frames are:



R.W. "Dick" Hill, Jr. [[we-r-led@hotmail.com](mailto:we-r-led@hotmail.com)]

P. O. BOX 41641, HOUSTON, TEXAS 77241

713-867-8909 (24 HRS)

# BANNERS & DOUBLE-SIDED MATERIAL

Go big or go home! It's a great motto when it comes to marketing so promote in large-scale illuminated banners.

Featured:

- 2 ft. x 8 ft. "Monster Energy"
- 4 ft. x 5 ft. Monster Claw

Available in multiple sizes



Our preferred vendors for banners are:



R.W. "Dick" Hill, Jr. [[we-r-led@hotmail.com](mailto:we-r-led@hotmail.com)]

P. O. BOX 41641, HOUSTON, TEXAS 77241

713-867-8909 (24 HRS)



# CUSTOM-WRAPPED BEAMS

Because of its flexibility, Printed Light™ can be placed just about anywhere; including custom-wrapped beams. It can light up any outdoor banner material.

Featured:

- 132" x 32<sup>3/4</sup>" beam
- Custom size panel adhered to beam with Velcro
- 140 sq. ft. driver with 2 leads



Printed Light™ Panels retrofitted around beams

Our preferred vendors for Custom Wraps are:



R.W. "Dick" Hill, Jr. [[we-r-led@hotmail.com](mailto:we-r-led@hotmail.com)]

P. O. BOX 41641, HOUSTON, TEXAS 77241

713-867-8909 (24 HRS)

# LONG ELLIPTICAL SIGN HOLDER

Great for directories, show rooms, lobbies and displays in many environments, including parking garages, airports, hospitals, office buildings, campuses and libraries, etc.

Featured:

- 48" x 84" stand with three 24" x 48" Printed Light™ panels and three 8" x 48" Printed Light™ panels.

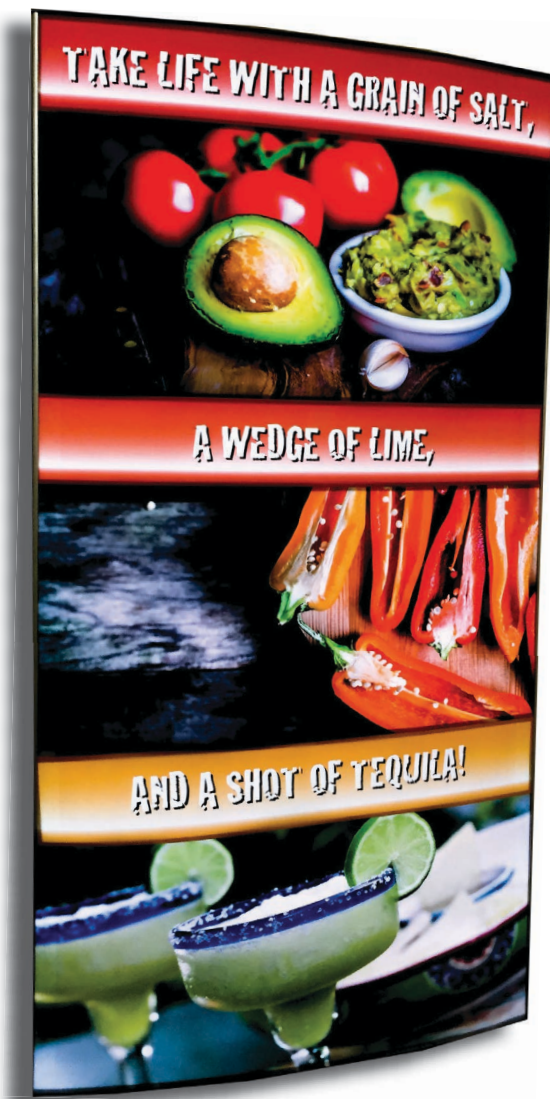
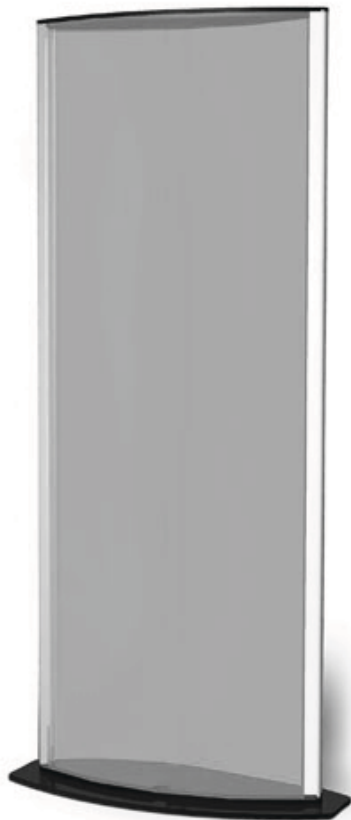

Our preferred vendor for elliptical sign holders are:



R.W. "Dick" Hill, Jr. [ [we-r-led@hotmail.com](mailto:we-r-led@hotmail.com) ]

P. O. BOX 41641, HOUSTON, TEXAS 77241

713-967-8909 (24 HRS)

# CUSTOM SEAT LIGHTING

Give your vehicle a personal touch & cruise in style with custom-built illuminated seat designs.

Featured:

- 24" x 36" panel on each seat connected to a DC driver
- Assembled by West Coast Customs



Our preferred vendor for custom seat lighting is:



R.W. "Dick" Hill, Jr. [[we-r-led@hotmail.com](mailto:we-r-led@hotmail.com)]

P. O. BOX 41641, HOUSTON, TEXAS 77241

713-867-8909 (24 HRS)

# CAR DOOR MAGNET

Safety enhanced while changing a tire or towing and magnet can be used to redirect traffic in any situation.



R.W. "Dick" Hill, Jr. [[we-r-led@hotmail.com](mailto:we-r-led@hotmail.com)]

P. O. BOX 41641, HOUSTON, TEXAS 77241

713-867-8909 (24 HRS)

# ENHANCED VISIBILITY VEST(PREMIUM)

Premium:  
C542/Lime  
C543/Orange

## Features:

- Comfortable Ultra-Cool™ 100% polyester mes material on back with solid front. Zipper front closure.
- 2" wide high performance reflective material with 3" contrasting color. Left

and right chest mic tabs.

## Pockets:

- Two lower outside patch pockets with flaps. Right chest 2-tier, 4-division pocket.
- Left chest radio pocket with flap. Two lower inside patch pockets.



Our preferred vendor for  
Enhanced Visibility Vests:



R.W. "Dick" Hill, Jr. [[we-r-led@hotmail.com](mailto:we-r-led@hotmail.com)]

P. O. BOX 41641, HOUSTON, TEXAS 77241

713-867-8909 (24 HRS)

# ENHANCED VISIBILITY VEST(STANDARD)

Premium:  
C544/Lime  
C545/Orange

Features:

- Lightweight 100% polyester solid material. Zipper front closure.
- 2" wide high performance reflective material.
- Left chest mic tab.

Pockets:

- Two lower outside patch pockets with flaps.
- Left chest radio pocket.
- Right chest 4-division pencil pocket.
- Two inside patch pockets.



Our preferred vendor for  
Enhanced Visibility Vests:



Healthy  
Green  
Seal

**1<sup>ST</sup> CHOICE**  
Innovative Lighting solution advancements™

R.W. "Dick" Hill, Jr. [[we-r-led@hotmail.com](mailto:we-r-led@hotmail.com)]

P. O. BOX 41641, HOUSTON, TEXAS 77241

713-867-8909 (24 HRS)

# ENHANCED VISIBILITY VEST(ECONOMY)

Premium:  
C546/Lime  
C547/Orange

Pockets:  
• Left chest pocket.

Features:

- 100% polyester mesh.
- Zipper front closure.
- 2" wide reflective material.
- Left chest mic tab.



Our preferred vendor for  
Enhanced Visibility Vests:



R.W. "Dick" Hill, Jr. [[we-r-led@hotmail.com](mailto:we-r-led@hotmail.com)]

P. O. BOX 41641, HOUSTON, TEXAS 77241

713-867-8909 (24 HRS)